

LIFE CARING DESIGN



collezione  
**hug**  
collection

Il benessere in bagno  
inizia da qui...

Well-being in the bathroom  
starts from here...

  
PONTE GIULIO

**Collezione HUG**  
la cura di sé parte da qui.

**Un sistema di arredo per tutta la famiglia  
che coniuga qualità, funzionalità, confort e  
sicurezza.**





## HUG collection

Taking care of oneself starts from here

A furnishing system for the whole family,  
blending quality, functionality, comfort and  
safety



... tutto a portata di mano!





... everything at your fingertips!



## La collezione HUG in sintesi

HUG collection at a glance

- 1** Maniglione dritto, 38 cm.  
Straight, 38 cm. grab bar  
G18UAS32
- 1a** Maniglione dritto, 48 cm.  
Straight, 48 cm. grab bar  
G18UAS33
- 1b** Maniglione dritto, 68 cm.  
Straight, 68 cm. grab bar  
G18UAS35
- 1c** Maniglione dritto, 100 cm.  
Straight, 100 cm. grab bar  
G18UAS38
- 2** Maniglione dritto, 175 cm.  
Straight, 175 cm. grab bar  
G18UAS40
- 3** Maniglione verticale, 175 cm.  
Vertical, 175 cm. grab bar  
G18UAS41
- 4** Sostegno ribaltabile, 60 cm.  
Removable and folding arm  
G18JCS07
- 4a** Sostegno ribaltabile, 70 cm.  
Removable and folding arm  
G18JCS08
- 4b** Sostegno ribaltabile, 85 cm.  
Removable and folding arm  
G18JCS09
- 5** Porta rotolo  
Toilet roll holder  
F18AGS03
- 6** Appendi abiti  
Clothes hook  
F18AKS02
- 7** Contenitore con ripiani  
Hang-on-grab bar cabinet  
F47APS07
- 8** Specchio con ripiani  
Hang-on-grab bar mirror  
F47ATS17
- 9** Contenitore chiuso  
Wall-mounted cabinet  
F47APS08
- 9a** Maniglia per contenitore  
Grab bar for cabinet  
F18UWS02
- 10** Contenitore con ripiani  
Wall-mounted cabinet  
F47APS06
- 10a** Maniglia per contenitore  
Grab bar for cabinet  
F18UWS01
- 11** Cassetto singolo  
Single drawer  
F47AIS01
- 12** Cassettiera  
Drawers  
F47AIS02

- 13** Contenitore per maniglia  
Removable Container  
F47ANS01
- 14** Mensola per maniglia  
Removable Shelf  
F47ANM10
- 15** Specchio fisso, 66x95 cm.  
Mirror 66x95 cm.  
F47ATS18
- 15a** Specchio fisso, 100x95 cm.  
Mirror 100x95 cm.  
F47ATS19
- 16** Specchio inclin. 66x76 cm.  
Tilting mirror 66x76 cm.  
F47JPS03
- 17** Sedile ribaltabile  
Folding seat  
G12JDS05 - G12JDS08
- 17a** Schienale  
Backrest  
G12JDS06
- 17b** Schienale con braccioli  
Backrest with armrests  
G12JDS07
- 18** Sgabello  
Stool  
G12JDS02
- 19** Seggiola  
Chair with backrest  
G12JDS04
- 20** Lavabo  
Washbasin  
B48CMM01
- 21** Console con catino su lato  
Console with bowl on side  
B48CNL01
- 21a** Console con catino su lato  
Console with bowl on side  
B48CNR01
- 22** Console con catino su lato  
Console with bowl on side  
B46CML22
- 22a** Console con catino su lato  
Console with bowl on side  
B46CMR22
- 23** Console con catino su lato  
Console sink  
B46CML23
- 23a** Console con catino su lato  
Console sink  
B46CMR23
- 24** Piatto doccia, quadrato  
Square shower tray  
B48CPM02
- 25** Piatto doccia, rettangolare  
Rectangular shower tray  
B48CPM03

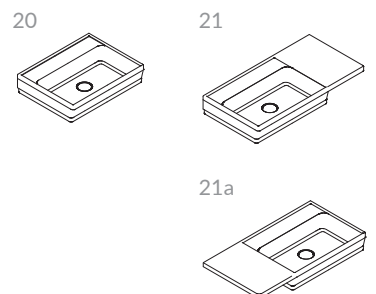
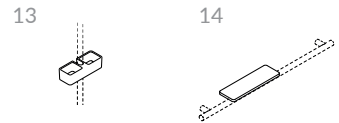
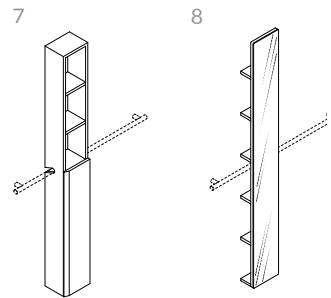
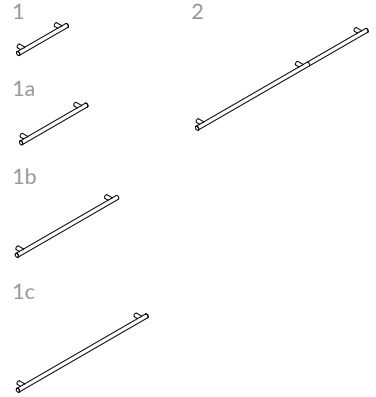



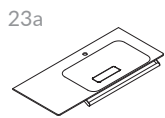
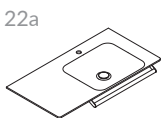
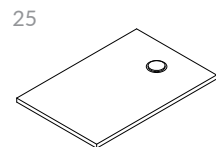
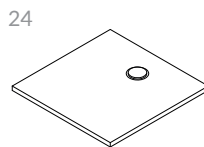
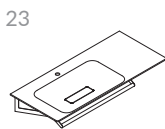
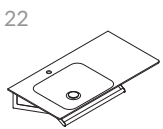
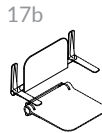
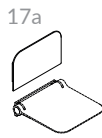
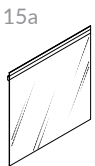
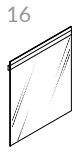
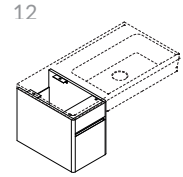
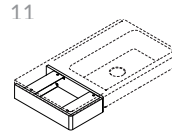
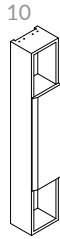
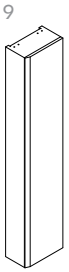
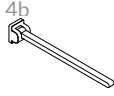
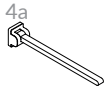

Il materiale con cui sono realizzati il lavabo e le consolle - legante sintetico e pietra dolomitica - è ecologico. Il trattamento esterno rende levigata, omogenea ed impermeabile la superficie, anche nelle zone nascoste, evitando la formazione di muffe e semplificando la pulizia.

The material used for the washbasin and console - synthetic binder and dolomitic stone - is environmentally friendly. The external treatment makes the surface smooth, homogeneous and waterproof, even in hidden areas, preventing the formation of mould and simplifying cleaning.

La consolle - B48CNL01 / B48CNR01 - offre un'ampia superficie a lato del catino posto in posizione ribassata per il contenimento dell'acqua. La forma, priva di angoli vivi, previene il rischio di traumi. L'articolo può essere integrato con un cassetto o una cassettera e munito di un braccio porta teli.

The console - B48CNL01 / B48CNR01 - offers a large surface area to the side of the basin, placed in a low position to contain the water. It can be integrated with a drawer or chest of drawers and fitted with a towel rail.

Il lavabo - B40CMM01 - ha un "labbro" per tutto il perimetro che delimita anche la superficie per il rubinetto, utile per poggiare oggetti bagnati. La forma, priva di angoli vivi, previene il rischio di traumi. L'articolo può essere munito di un braccio porta teli, integrato nel corpo del lavabo stesso.

The washbasin - B40CMM01 - has a "lip" around the entire perimeter that also delimits the surface for the tap, useful for placing wet objects. It can be fitted with a towel holder arm, integrated into the body of the washbasin.



Sinistro - Left Destro - Right

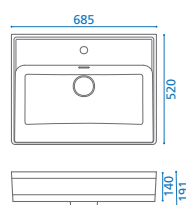
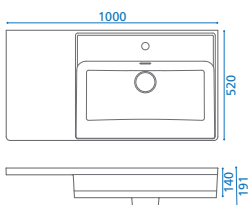

Misure espresse in millimetri  
Dimensions in millimetres









## Le consolle in Corian® - pietra acrilica

Sensuale ed elegante alla vista, calda al tatto, antibatterica e dalle forme morbide, la pietra acrilica è un materiale che si mantiene immutato nel corso degli anni. Le consolle possono essere realizzate completamente su misura e in colori diversi dal bianco.

### Corian® consoles - acrylic stone

Sensual and elegant to the eye, warm to the touch, antibacterial and softly shaped, acrylic stone is a material that remains unchanged over the years. The consoles can be made completely to measure and in colours other than white.

**Console in pietra acrilica**  
- Corian - B46CMR23 /  
B46CML23 - con catino su  
un lato, destro o sinistro, che  
prevede lo scarico a pozzetto  
con copertura.

L'articolo è munito di un  
telaio in acciaio con finitura  
epossipoliestere e braccio porta  
telo in acciaio inossidabile.

Console in acrylic stone - Corian  
- B46CMR23 / B46CML23 -  
with bowl on one side, right  
or left. Drainage with cover.  
The article is equipped with a  
steel frame in epoxy-polyester  
finish and a towel holder bar in  
stainless steel.



Sinistro - Left Destro - Right

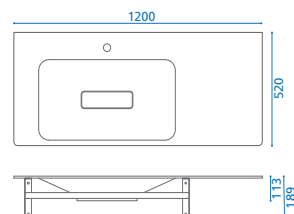

Misure espresse in millimetri  
Dimensions in millimetres

**Console in pietra acrilica**  
- Corian - B46CMR22 /  
B46CML22 - con catino su  
lato, destro o sinistro, munita  
di un telaio in acciaio con  
finitura epossipoliestere e  
braccio porta telo in acciaio  
inossidabile.

Console in acrylic stone  
- Corian - B46CMR22 /  
B46CML22 - with basin on  
right or left side, equipped  
with a steel frame in epoxy-  
polyester finish and a towel  
holder bar in stainless steel.

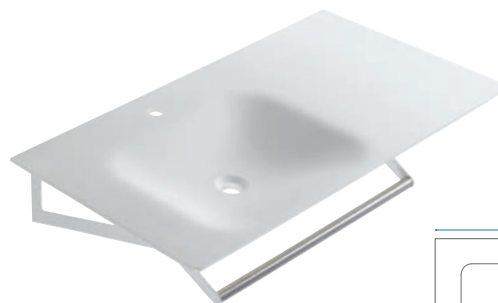

Sinistro - Left Destro - Right

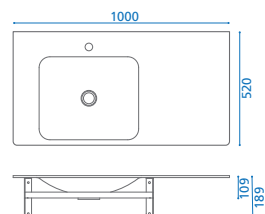



**Le console - B46CMR22-23 / B46CML22-23 - in pietra acrilica (solid surface) - vengono fissate a muro con un telaio in metallo. Per il sostegno del piano laterale è prevista una staffa accessoria. Qualora si scegliesse di acquistare la cassetteria o il cassetto, la staffa non è necessaria.**

The consoles - B46CMR22-23 / B46CML22-23 - in acrylic stone (solid surface) - are fixed to the wall with a metal frame. An accessory bracket is provided to support the side countertop. If you choose to purchase the chest of drawers or the drawer, the bracket is not needed.

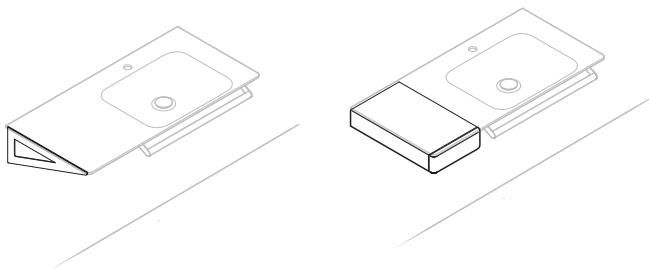



Le console - B48CNR01 / B48CNL01 - in composito minerale vengono fissate a muro per mezzo di tasselli e viti. Per il sostegno del piano laterale è prevista una staffa accessorio. Qualora si scegliesse di acquistare la cassettera o il cassetto, la staffa non è necessaria.

The consoles - B48CNR01 / B48CNL01 - made of mineral composite are fixed to the wall using dowels and screws. An accessory bracket is provided to support the side countertop. If you choose to purchase the chest of drawers or the drawer, the bracket is not needed.

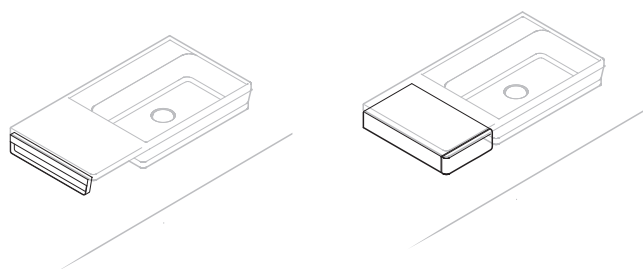



La maniglia è concepita come un elemento che può rappresentare una costante nello spazio del bagno, finalizzata non solo ed esclusivamente per la “sicurezza”, come appiglio, ma anche come supporto per vari elementi come uno specchio, un mobile o una mensola. In questo modo diventa un elemento strutturale che consente di predisporre lo spazio come si preferisce.

The grab bar is conceived as a constant element in the bathroom space, aimed not only and exclusively to “safety”, therefore as a handhold, but also as a support for various elements such as a mirror, a piece of furniture or a shelf. In this way it becomes a structural element that allows you to arrange the space as you wish.



La forma a terminale tronco e l'adozione di un cilindro per il fissaggio a muro, determinano l'essenzialità e l'eleganza delle maniglie “Prestigio+”. L'ancoraggio a muro è garantito tramite una sola vite per mezzo del “cilindro” che è posto alle due estremità della maniglia.

Le maniglie “Prestigio+” sono realizzate con materie prime di qualità e offrono una varietà di finiture che ne consentono l'uso in ogni tipo di ambiente.

The cut-end shape and the adoption of a cylinder for wall fixing, determine the essentiality and elegance of the “Prestigio+” grab bars.

They are secured to the wall with a single screw by means of the “cylinder” at either end of the bar. The “Prestigio+” grab bars are made from quality raw materials and offer a variety of finishes that allow them to be used in any type of environment.









**L7**  
Tono "ciliegio"  
"cherrywood" tone



**W2**  
Bianco caldo  
Warm white



**N2**  
Acciaio lucido  
Polished steel



**R2**  
Rame  
Copper



**P5**  
Melanzana  
Aubergine



**G9**  
Lime  
Lime



**D8**  
Grigio ossido  
Oxide grey

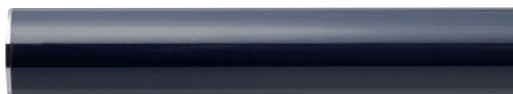

**DM**  
Nero seppia  
Cuttlefish black



**E2**  
Oro rosa  
Rose gold



**E3**  
Oro satinato  
Satin gold



**E4**  
Oro rosa satinato  
Satin rose gold



**E5**  
Nickel nero satinato  
Satin black nickel



**E6**  
Bronzo scuro satinato  
Dark satin bronze



**E7**  
Nickel bronzo satinato  
Satin bronze nickel



Le maniglie "Prestigio+" sono anticonvenzionali sia per i materiali scelti, il legno massello o l'acciaio inossidabile, sia per le finiture.

Oltre alle tradizionali proposte in colore bianco o dell'acciaio levigato, lucido e satinato, le maniglie "Prestigio+" vengono proposte con trattamenti particolari per ottenere effetti come l'oro rosa o il nickel.

I cilindri di ancoraggio a muro ed i tappi terminali sono proposte esclusivamente con finitura cromata.

The "Prestigio+" grab bars are unconventional both in the materials chosen, solid wood or stainless steel, and in the finishes. In addition to the traditional white or smooth steel, polished and satin finishes, "Prestigio+" grab bars are also available with special treatments to obtain effects such as rose gold or nickel.

The wall-anchoring cylinders and end caps are always rigorously with a chrome finish.

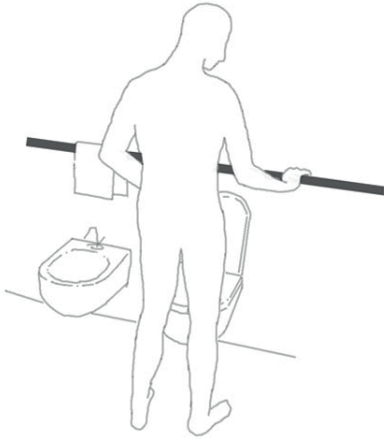
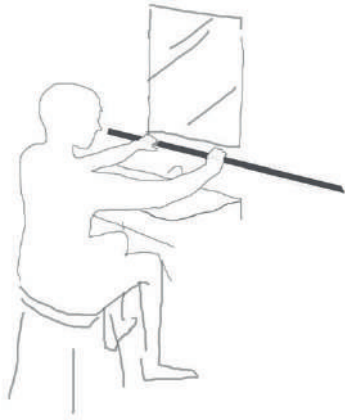

Le maniglie "Prestigio+" possono essere installate dove ce n'è più bisogno. In questo modo viene garantita una presa sicura sempre a portata di mano:

- Sopra al lavabo
- Vicino alla vasca
- Dentro la doccia
- Lungo i percorsi di spostamento nell'ambiente

"Prestigio+" grab bars can be installed where they are most needed. This ensures that a secure grip is always at hand:

- Above the washbasin
- Next to the bath tub
- Inside the shower
- Along movement paths

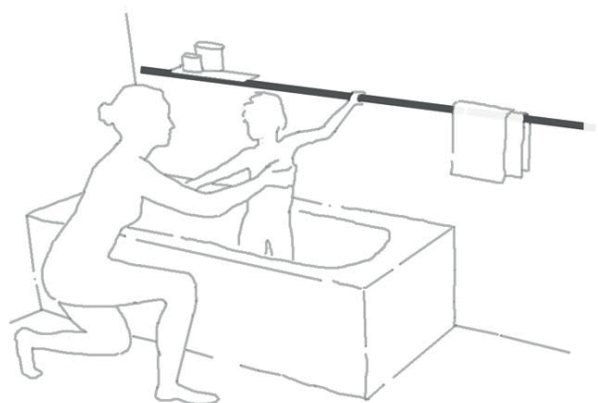



La mensola - F47ANS01 - in pietra acrilica - può essere alloggiata su ogni maniglia orizzontale. Facilmente rimovibile offre un pratico piano per riporre qualunque oggetto. Non richiede tasselli e può essere usata dove è più utile.

The shelf - F47ANS01 - made of acrylic stone - can be placed on any horizontal grab bar. It is easily removable and offers a practical surface for storing any object. It does not require anchors and can be used wherever it is most useful.

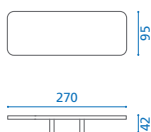
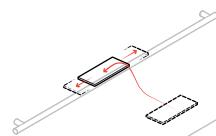

Misure espresse in millimetri  
Dimensions in millimetres





Misure espresse in millimetri  
Dimensions in millimetres

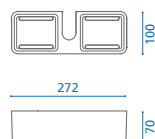

Il porta oggetti - F47ANS01 - in poliuretano ad alta densità, può essere installato su qualunque maniglia verticale. Adattabile in altezza e facilmente rimovibile, può essere impiegato in ogni angolo del bagno. L'ancoraggio su una maniglia non richiede l'uso di viti per il fissaggio a parete.

The container- F47ANS01- made of high-density polyurethane, can be installed on any vertical grab bar. It is height-adjustable and easily removable. It can be used in any corner of the bathroom and fits on a bar without the use of screws.

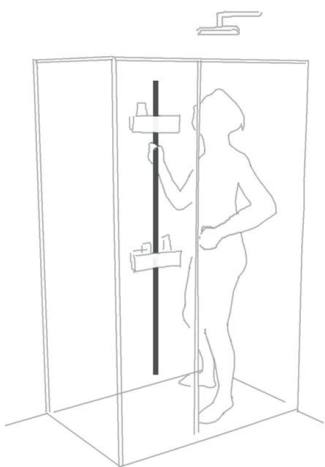
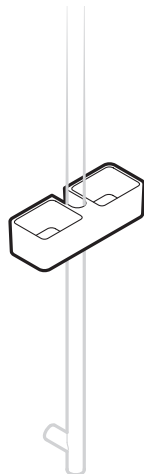
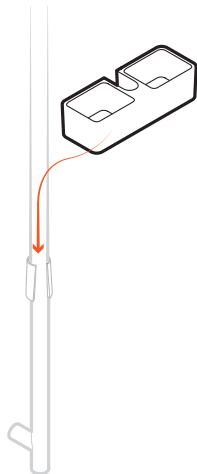









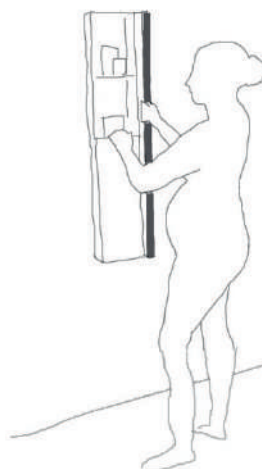
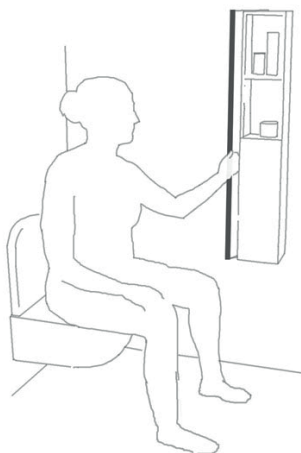

**Il mobile contenitore, da installare a parete, può essere munito anche di una maniglia di sicurezza diventando in questo modo un unico elemento di arredo.**

**La maniglia, fissata direttamente a parete, garantisce una tenuta a carico fino a 120 kg. Il mobile ad essa ancorato, consente di riporre tutti i propri oggetti, in modo che siano sempre ordinati e a portata di mano.**

**Il "sistema" maniglia-contenitore può essere posizionato dovunque ci sia bisogno di un sostegno o un piccolo aiuto per muoversi, sedersi, alzarsi.**

**L'ancoraggio alla maniglia del contenitore, evita ulteriori fori sulle pareti ottimizzando l'installazione.**

The wall-mounted storage unit can also be equipped with a safety bar, thus becoming a single piece of furniture.

The grab bar, which is fixed directly to the wall, can withstand loads of up to 120 kg. The cabinet anchored to it allows you to store all your objects so that they are always tidy and within easy reach.

The storage unit+bar -can be positioned wherever there is a need for support or a little help in moving, sitting or standing up.

The anchorage of the unit to the bar, avoids additional holes in the walls, optimising installation.







I contenitori a parete possono essere muniti di vere e proprie maniglie di sicurezza con una capacità di resistenza a carico, in tutte le direzioni di **120 kg**. Offrono un facile e sicuro appiglio a chi necessita di muoversi per mezzo di ausili.

I contenitori, così come le maniglie, sono reversibili quindi possono essere installati sia a destra sia a sinistra.

Le staffe di fissaggio sono predisposte per agganciare i contenitori, questo evita la necessità di fare ulteriori fori per il fissaggio del contenitore

The wall containers can be fitted with safety bars with a load-bearing capacity of **120 kg** in all directions.

They provide a safe and easy foothold for people who need to move around with aids.

The containers, as well as the bars, are reversible so they can be installed on either the right or left side. The fixing brackets are designed to anchor the container, avoiding the need to drill additional holes to fix the storage unit.

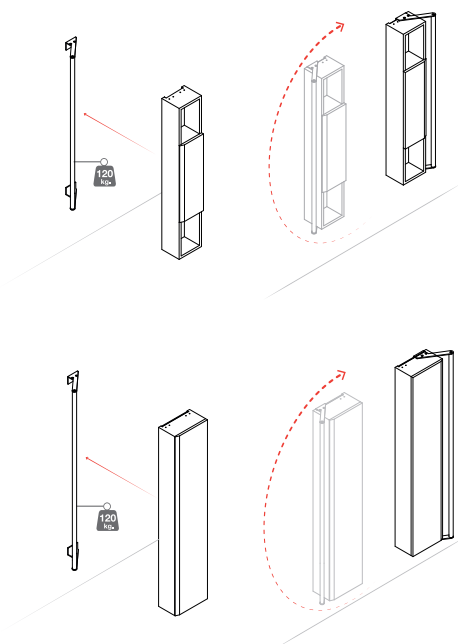







**Il contenitore - F47APS07 - può essere inserito su una maniglia orizzontale qualsiasi, e posto liberamente per tutta la lunghezza senza alcun vincolo, in base al concetto del "tutto a portata di mano".**

The container - F47APS07 - can be placed on any horizontal bar and positioned freely along its entire length without any constraints, based on the concept of 'everything within reach'.

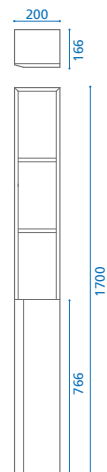
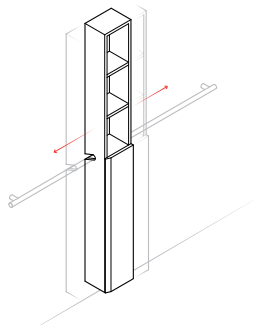
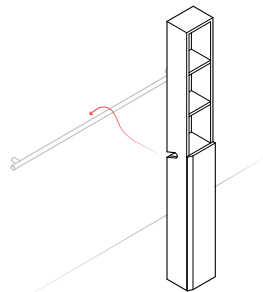

Misure espresse in millimetri  
Dimensions in millimetres



Lo specchio con ripiani - F47ATS17 - da agganciare su maniglia orizzontale, può essere inserito su una maniglia qualsiasi, e posto liberamente per tutta la lunghezza senza alcun vincolo, in base al concetto del **“tutto a portata di mano”**.  
Lo specchio a **“tutta altezza”** - 175 cm. - è anche un funzionale contenitore per i vari oggetti sempre utili in bagno.

The mirror with shelves - F47ATS17 - can be hooked onto a horizontal bar and be positioned freely along its entire length without any constraints, according to the concept of **“everything within reach”**.

The **“full height”** mirror - 175 cm. - incorporates also a functional container for the various objects always needed in the bathroom.

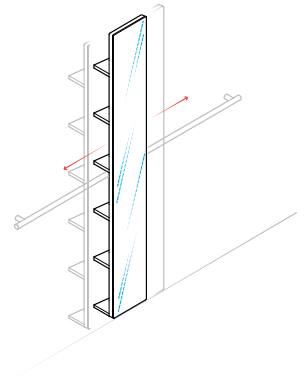
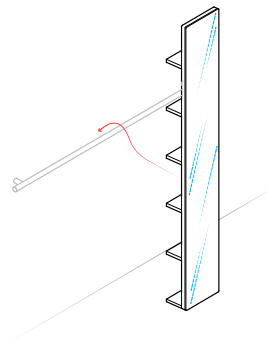
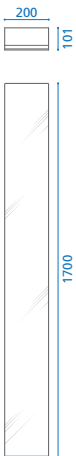
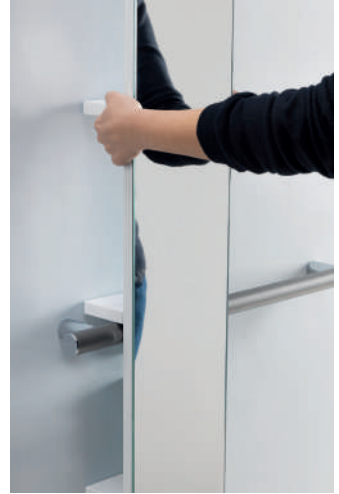
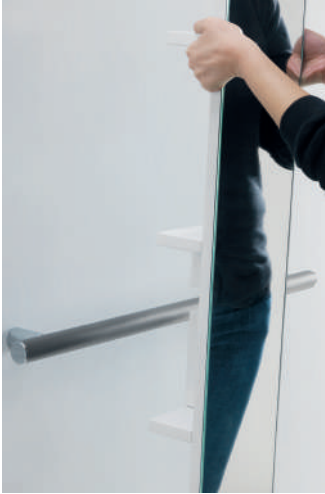

Misure espresse in millimetri  
Dimensions in millimetres



Un appendi abiti e un porta-rotolo, due semplici oggetti trasformati in elementi di arredo con una intuizione stilistica; entrambi gli oggetti sono proposti con il corpo in tubo di acciaio, dello stesso diametro usato per la maniglia. Una estremità è "terminata" da un elemento a "testa di chiodo" che caratterizza fortemente questi oggetti e al tempo stesso svolge la funzione di "fermo" per il rotolo o per un accappatoio. Dal punto di vista delle finiture la testa è disponibile solo con finitura "cromo" mentre il "corpo" è proposto in cinque colori. Su richiesta i corpi di questi oggetti possono essere realizzati in tutti i colori con cui vengono proposte le maniglie.

A clothes hanger and a roll holder, two simple objects transformed into furnishing elements thanks to a stylistic intuition. Both objects are proposed with a steel tube body, with the same diameter used for the bars. One end is "nail headed", representing a nice design feature which, at the same time, acts as a "break" for the paper roll or bathrobe.

From the point of view of the finishes, the head is only available in "chrome" while the body is offered in five colours.

On request, the bodies can be realized in all the colours in which the bars are made.





Il sostegno ribaltabile HUG, è essenziale nelle forme, rendendolo adatto ad essere impiegato in qualunque ambiente bagno, quanto elegante e pratico grazie al braccio realizzato in alluminio.

L'articolo può essere corredato di un poggia braccia, in gomma e di un porta rotolo in acciaio inossidabile.

The HUG folding support is essential in form, making it suitable for use in any bathroom environment, as well as being elegant and practical thanks to its aluminium arm. The product can be equipped with a rubber armrest and a stainless steel roll holder.







60 cm.



70 cm.



85 cm.

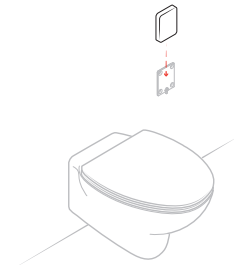
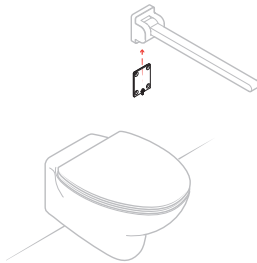
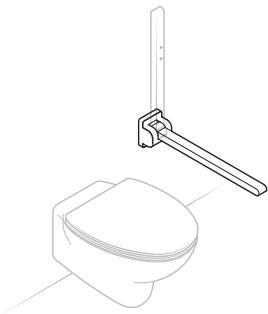

**Il bracciolo ribaltabile - G18JCS07/08/09 - viene ancorato a parete per mezzo di una piastra. Il sostegno è solidale ad una semi-piastra, munita di snodo. Questa scelta tecnica consente di rimuovere facilmente il sostegno dall'ancoraggio a muro; la piastra che rimane fissa a muro, può essere protetta da un elegante copri piastra in ABS. Il braccio è disponibile in tre lunghezze 60, 70 e 85 centimetri.**

The folding armrest - G18JCS07/08/09 - is fixed to the wall by means of a plate. The arm is attached to a semi-plate with a joint. This technical choice allows the arm to be easily removed from the wall anchorage and the plate, which remains fixed to the wall, can be protected by an elegant cover in ABS.

The arm is available in three lengths 60, 70 and 85 centimetres.











## Sedia e sgabello

Chiunque, senza distinzione di età, sesso o abilità, stando seduto può agevolmente affrontare le quotidiane azioni come sciacquarsi il viso, fare una doccia o prepararsi per il bagno.

### Chair and stool

Anyone, regardless of age, gender or ability, can easily perform everyday tasks such as rinsing their face, taking a shower or getting ready for a bath while sitting down.



**Gli elementi strutturali della sedia e dello sgabello sono realizzati con tubo di acciaio inossidabile.**

The structural elements of the chair and stool are made of stainless steel tubing.

**Le gambe della sedia e dello sgabello sono munite di piedini anti-scivolo regolabili.**

The legs of the chair and stool are fitted with adjustable non-slip feet.

**Lo sgabello e la sedia vengono venduti con le parti smontate. L'assemblaggio è semplice, ogni parte della struttura viene fissata al piano di seduta per mezzo di tre viti.**

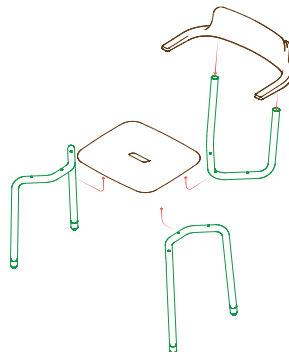

The stool and chair are sold with the parts disassembled. The assembly is simple, each part of the structure is fixed to the seating surface by means of three screws.



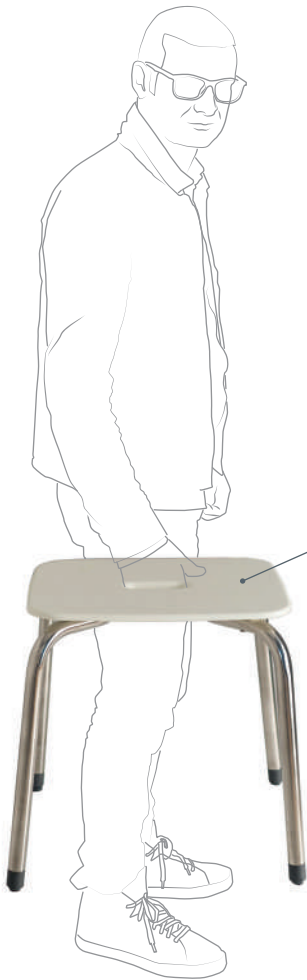

**La sedia e lo sgabello sono molto leggeri - 7,2 Kg. la sedia, 5 kg. lo sgabello - entrambi possono essere sollevati e trasportati grazie alla fessura posta al centro della seduta.**

The chair and stool are very light - 7.2 kg. the chair, 5 kg. the stool. They can both be lifted and easily transported thanks to the slot in the centre of the seat.

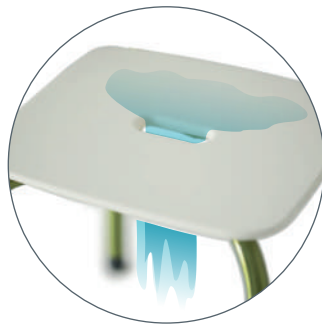

**La fessura di cui è provvisto il piano di seduta della sedia e dello sgabello ha anche la funzione di far defluire rapidamente l'acqua nel caso di uso sotto la doccia.**

The slit in the seat of the chair and stool also serves to allow water to drain away quickly when used in the shower.

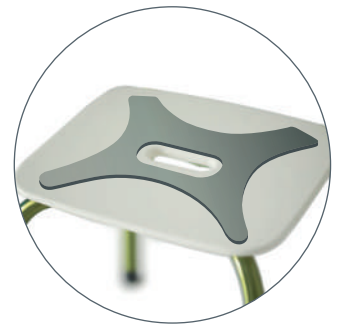

**Il piano di seduta della sedia e dello sgabello ha un rinforzo interno in acciaio. Questo rende estremamente rigido e solido questo sottile ed importante elemento**

The seat of the chair and stool has an internal steel reinforcement. This makes this slender chair and stool extremely rigid and solid.







## Sedile doccia ribaltabile con schienale

Il sedile doccia è stato pensato per poter rispondere a diverse esigenze ma anche per consentire una dinamica evoluzione. Per tale ragione abbiamo previsto un sedile a cui può essere aggiunto uno schienale con o senza braccioli.

### Fold-down shower seat with backrest

The shower seat is designed to meet different requirements but also to allow for dynamic evolution. For this reason we have provided a seat to which a backrest can be added with or without armrests.



**Il colore bianco è una scelta obbligata quando si deve realizzare un articolo destinato al bagno. Il grigio è la proposta per chi cerca un contrasto non convenzionale. Il rosso è destinato a coloro i quali cercano nuove ispirazioni.**

**In aggiunta a questi tre colori - Bianco segnale, Grigio grafite e Rosso corallo - possono essere realizzati su richiesta tutti i colori del sistema di identificazione dei colori RAL.**

The colour white is a must-have when producing an article for the bathroom. Grey is for those looking for an unconventional contrast. Red is for those seeking a new inspiration.

In addition to these three colours - Signal White, Graphite Grey and Coral Red - all colours of the RAL colour system can be produced on request.



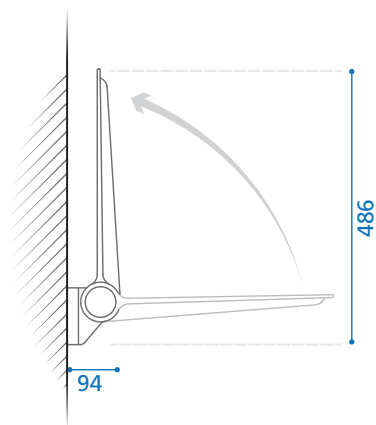

**Il sedile per doccia HUG, è caratterizzato da forme semplici e da una ampia superficie di seduta.**

The HUG shower seat is designed with simple shapes and a large seating area.

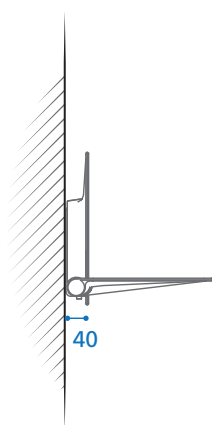
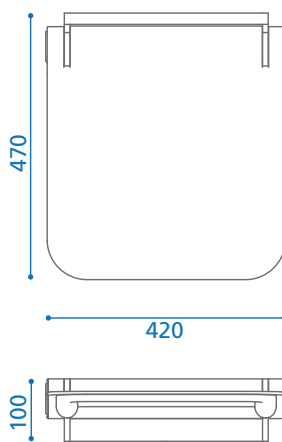

**Lo schienale, con o senza braccioli, è un complemento indispensabile per il sedile doccia HUG.**

The backrest, with or without armrests, is an indispensable complement to the HUG shower seat.

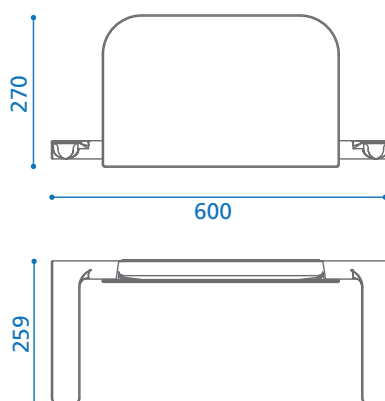

Misure espresse in millimetri  
Dimensions in millimetres



**Il sedile doccia della collezione HUG è stato concepito per rispondere a qualunque esigenza di installazione; esistono tre diverse flange di fissaggio: due di queste sono ad ancoraggio fisso, una prevede la piastra removibile che consente di togliere il sedile dalla parete.**

**Spesso nei contesti dell'ospitalità avere la possibilità di offrire un servizio aggiuntivo, come un sedile nella doccia, rimovibile all'occorrenza, si rivela un utile soluzione ed una apprezzata delicatezza da parte degli ospiti che ne potrebbero avere bisogno.**

The shower seat from the HUG collection is designed to meet any installation requirement; there are three different fixing flanges: two of them are fixed anchors and one has a removable plate that allows the seat to be removed from the wall.

Often in hospitality environments, having the possibility to offer an additional service, such as a seat in the shower that can be removed if necessary, proves to be a useful solution and an appreciated gesture by guests who may need it.



## Piatti doccia in Mineral Composite

Il composto sintetico con cui sono realizzati questi articoli presenta proprietà chimico-fisiche impareggiabili. Il rivestimento in resina polimerizzata conferisce alla superficie una levigatezza ed una omogenità uniche, inoltre è resistente agli urti ed è caldo al tatto.

## Shower trays made of Mineral Composite

The synthetic compound from which these items are made has unparalleled chemical and physical properties. The polymerised resin coating gives the surface a unique smoothness and homogeneity. It is also impact resistant and warm to the touch.

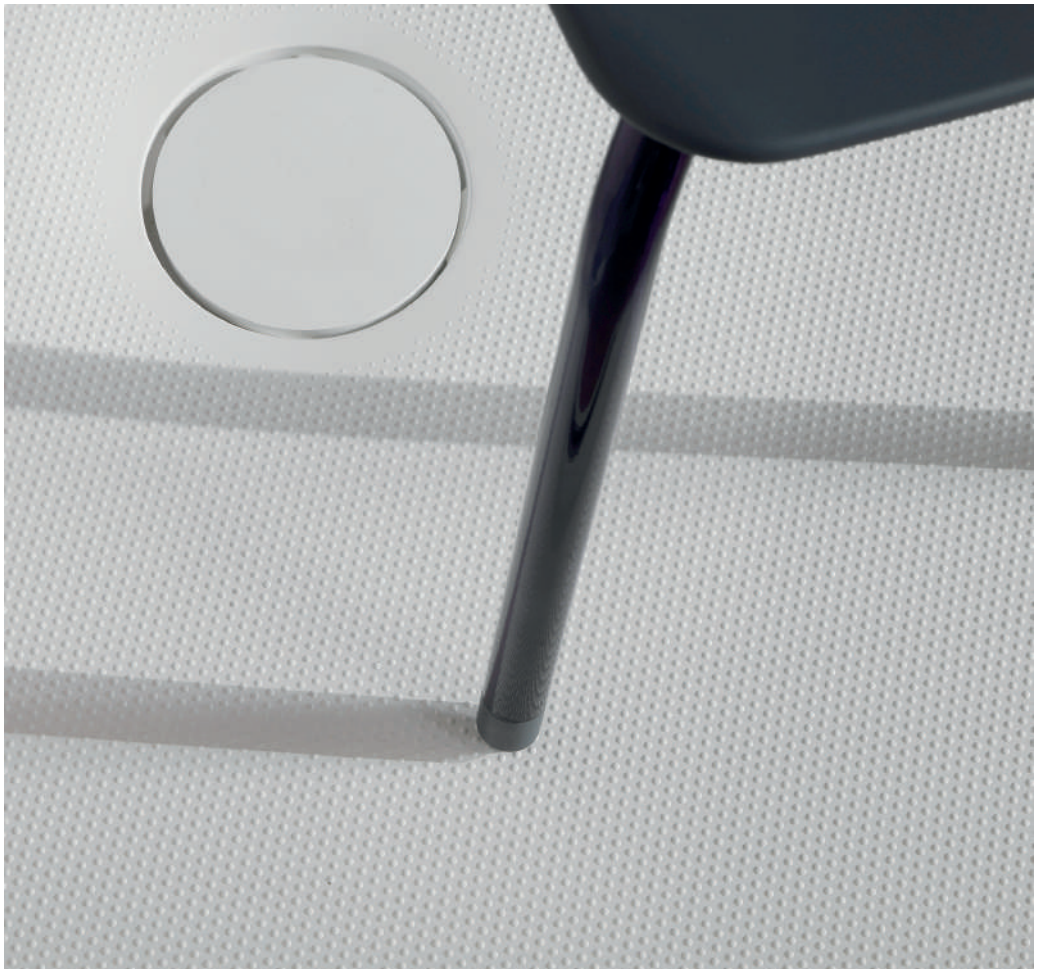



**Piatto doccia rettangolare 120x80 cm. - B48CPM03**  
- con superficie punteggiata a rilievo. Questo trattamento offre un confortevole contatto con la pianta del piede e contribuisce a ridurre il rischio di scivolare.

**Il piatto consente il montaggio sia a filo pavimento sia sopra pavimento.**

Rectangular shower tray 120x80 cm. - B48CPM03  
- with an embossed dotted surface. This treatment provides comfortable contact with the soles of the feet and helps reduce the risk of slipping.

The tray can be installed either flush with the floor or above it.



**Piatto doccia quadrato 90x90 cm. - B48CPM02** - con superficie punteggiata a rilievo. Questo trattamento offre un confortevole contatto con la pianta del piede e contribuisce a ridurre il rischio di scivolare.

**Il piatto consente il montaggio sia a filo pavimento sia sopra pavimento.**

Square shower tray 90x90 cm. - B48CPM02 - with an embossed dotted surface. This treatment provides comfortable contact with the soles of the feet and helps reduce the risk of slipping.

The tray can be installed either flush with the floor or above it.



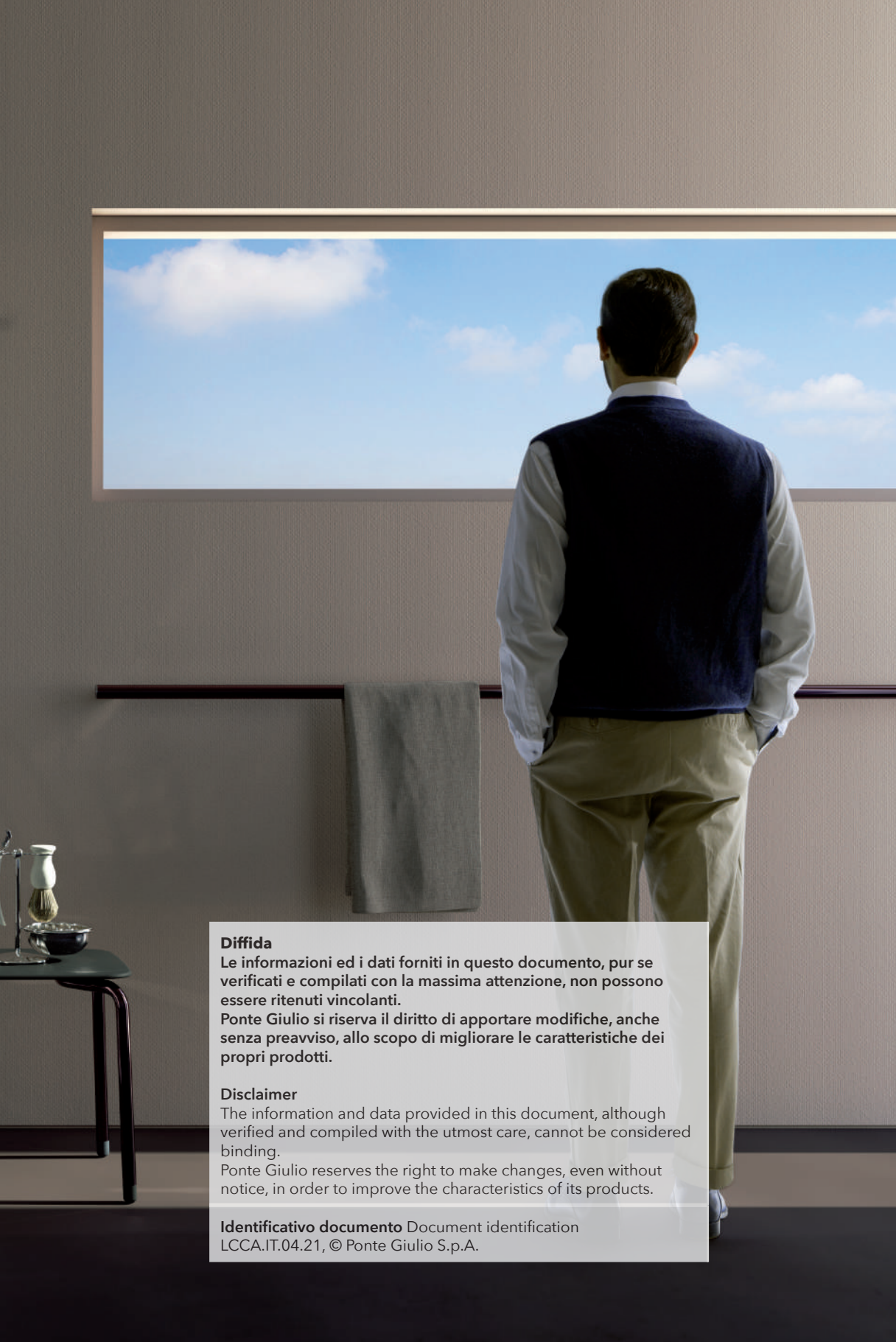

**Diffida**

Le informazioni ed i dati forniti in questo documento, pur se verificati e compilati con la massima attenzione, non possono essere ritenuti vincolanti.

Ponte Giulio si riserva il diritto di apportare modifiche, anche senza preavviso, allo scopo di migliorare le caratteristiche dei propri prodotti.

**Disclaimer**

The information and data provided in this document, although verified and compiled with the utmost care, cannot be considered binding.

Ponte Giulio reserves the right to make changes, even without notice, in order to improve the characteristics of its products.

**Identificativo documento** Document identification  
LCCA.IT.04.21, © Ponte Giulio S.p.A.





**Ponte Giulio S.p.A.**

Località Ponte Giulio 05018 Orvieto (TR) ITALY

☎ +39 0763 316044

☎ +39 0763 316043

☎ 366 2654238

**Ponte Giulio USA Corp.**

W241 S4021 Rockwood Circle

Waukesha, WI 53189 - USA

☎ 1.877.766.8301

☎ 1.877.766.8306